

Electronic Throttle Body

www.bosch-motorsport.com

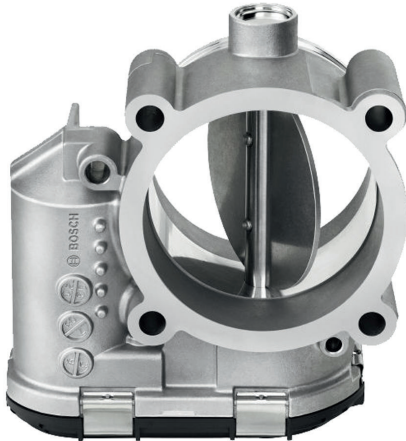

- ▶ Many bore diameters available
- ▶ Throttle position sensor is redundant
- ▶ For flex-fuel, CNG, LPG
- ▶ Idle default position

The throttle body is designed to control the fresh air of spark ignition engines in combination with an electronic throttle control system. ETB applications with flex-fuel, CNG and LPG are permissible if injected in the air flow after the throttle body.

A typical ETC system includes the following components: electronic throttle body, accelerator pedal module and electronic control unit.

You will find the available bore diameters in the variations table.

Application

Temperature range	-40 to 140°C
Max. vibration	50 to 250 m/s ² at 50 Hz to 2 kHz

Technical Specifications

Mechanical Data

Available bore diameters	32 mm
	40 mm
	44 mm
	46 mm
	50 mm
	52 mm
	54 mm
	60 mm

82 mm

Electrical Data

Supply voltage	6 to 16 V
Supply voltage sensor	5 ± 0.2 V
Max. allowed generator current	<10.0 A

Characteristic

Output signal I	0 to 5 V for 0 to 90°
Output signal II	5 to 0 V for 0 to 90°

Connectors and Wires

Various motorsport and automotive connectors are available on request.

Please specify the required wire length with your order.

Installation Notes

For correct mounting please respect the hints on the next page "Mounting position".

The ETB can be connected directly to control units with ETC functionality.

Please find further application hints in the offer drawing at our homepage.

Two redundant sensors control the up to date throttle position.

All ETBs have an idle air position.

Ordering Information

Electronic Throttle Body 32 mm

Order number **0 280 750 148**

Electronic Throttle Body 40 mm

Order number **0 280 750 149**

Electronic Throttle Body 44 mm

Order number **0 280 750 137**

Electronic Throttle Body 46 mm

Order number **F 02U V01 171-01**

Electronic Throttle Body 50 mm

Order number **0 280 Y05 107-10**

Electronic Throttle Body 52 mm

Order number **F 02U V01 184-01**

Electronic Throttle Body 54 mm

Order number **0 280 750 150**

Electronic Throttle Body 60 mm

Order number **0 280 750 151**

Electronic Throttle Body 68 mm

Order number **0 280 750 156**

Electronic Throttle Body 82 mm

Order number **0 280 750 101**

Dimensions

Mounting position

Mounting position of the Throttle Actuator



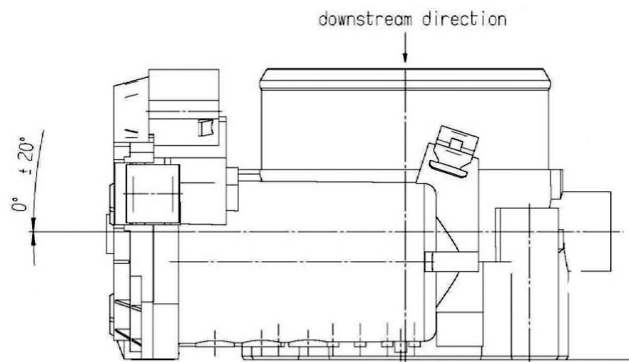

- Horizontal inclination of the Throttle shaft: $\pm 20^\circ$
- Horizontal inclination of the cover: $\pm 180^\circ$
- Mounting positions which deviate from this need separate testing.
- It has to be prevented that when mounted in the vehicle, no condensed moisture can soak into the Throttle shaft bore holes (e.g. from the crankcase ventilation)

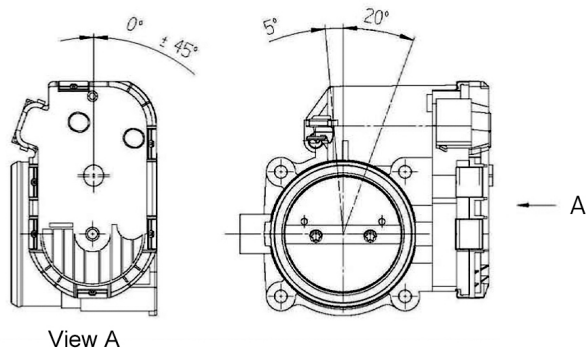





IN CASE OF MOUNTING POSITION WITH DC-MOTOR ON TOP
A COMBINATION OF THE ANGLES SHOWN BELOW IS NOT ALLOWED!



Electronic Throttle Body Variations

	Electronic Throttle Body 32 mm	Electronic Throttle Body 40 mm	Electronic Throttle Body 44 mm	Electronic Throttle Body 46 mm	Electronic Throttle Body 50 mm
					
Bore diameter (mm)	32	40	44	46	50
Connector	D 261 205 358-01	D 261 205 358-01	D 261 205 358-01	D 261 205 356-01	D 261 205 356-01
Pin 1 A	Motor -	Motor -	Motor -	Poti 1	Poti 2
Pin 2 B	Poti -	Poti -	Poti -	Poti -	Poti -
Pin 3 C	Poti +	Poti +	Poti +	Motor -	Motor +
Pin 4 D	Motor +	Motor +	Motor +	Poti 2	Poti 1
Pin 5 E	Poti 2	Poti 2	Poti 2	Motor +	Motor -
Pin 6 F	Poti 1	Poti 1	Poti 1	Poti +	Poti +
Flange diameter (mm)	40	50	50	58	58
Weight (kg)	0,9	0,9	0,9	0,95	0,95
Max. air flow rate*	394 kg/h at 85° angle	695 kg/h at 85° angle	Not specified	978 kg/h at 85° angle	Not specified
Opening direction **	counterclockwise	counterclockwise	counterclockwise	clockwise	counterclockwise

	Electronic Throttle Body 52 mm	Electronic Throttle Body 54 mm	Electronic Throttle Body 60 mm	Electronic Throttle Body 68 mm	Electronic Throttle Body 82 mm
					
Bore diameter (mm)	52	54	60	68	82
Connector	D 261 205 356-01	D 261 205 358-01	D 261 205 358-01	D 261 205 358-01	D 261 205 358-01
Pin 1 A	Poti 1	Motor -	Motor -	Motor -	Motor -
Pin 2 B	Poti -	Poti -	Poti -	Poti -	Poti -
Pin 3 C	Motor -	Poti +	Poti +	Poti +	Poti +
Pin 4 D	Poti 2	Motor +	Motor +	Motor +	Motor +
Pin 5 E	Motor +	Poti 2	Poti 2	Poti 2	Poti 2
Pin 6 F	Poti +	Poti 1	Poti 1	Poti 1	Poti 1
Flange diameter (mm)	58	70	68,5	75	90
Weight (kg)	0,95	0,95	0,95	1,1	1,1
Max. air flow rate*	Not specified	Not specified	Not specified	Not specified	Not specified
Opening direction **	clockwise	counterclockwise	counterclockwise	counterclockwise	counterclockwise

* ambient conditions: Air pressure $p=1000$ mbar, Differential pressure $\Delta p=600$ mbar ± 25 mbar, rel. humidity $rF=40$ %, Air temperature $T=24^{\circ}\text{C}$

** Opening direction is related to view A. See drawings on bottom of chapter "Dimensions".

Represented by:

Europe:
Bosch Engineering GmbH
Motorsport
Robert-Bosch-Allee 1
74232 Abstatt
Germany
Tel.: +49 7062 911 9101
Fax: +49 7062 911 79104
motorsport@bosch.com
www.bosch-motorsport.de

North America:
Bosch Engineering North America
Motorsport
38000 Hills Tech Drive
Farmington Hills, MI 48331-3417
United States of America
Tel.: +1 248 876 2977
Fax: +1 248 876 7373
motorsport@bosch.com
www.bosch-motorsport.com

Latin America:
Robert Bosch Ltda
Motorsport
Av Juscelino Kubitscheck de
Oliveira 11800
Zip code 81460-900
Curitiba - Parana
Brasilia
Tel.: +55 41 3341 2057
Fax: +55 41 3341 2779

Asia-Pacific:
Bosch Engineering Japan K.K.
Motorsport
18F Queen's Tower C, 2-3-5 Minato Mirai
Nishi-ku, Yokohama-shi
Kanagawa 220-6218
Japan
Tel.: +81 45 650 5610
Fax: +81 45 650 5611
www.bosch-motorsport.jp

Australia, New Zealand and South Africa:
Robert Bosch Pty. Ltd
Motorsport
1555 Centre Road
Clayton, Victoria, 3168
Australia
Tel.: +61 (3) 9541 3901
motor.sport@au.bosch.com